

Tube clamp

InfraRentals supported by Dieseko Group

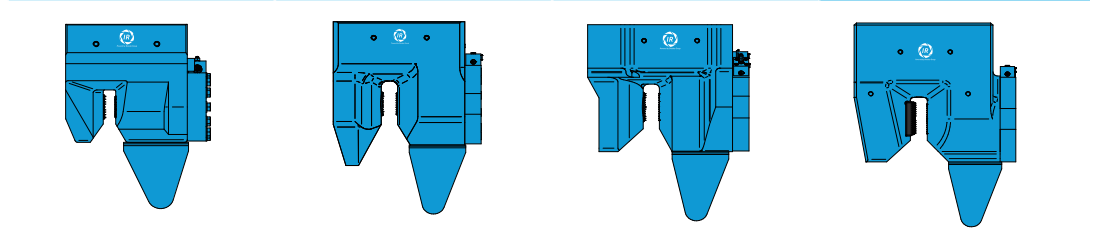

	55TC	80TC	100TC	125TC
Clamping force (kN)	550	800	1000	1250
Working pressure (bar)	300	300	300	300
Max. operating press. (bar)	180	180	180	180
Min. inside tube ϕ (mm)	294	417	480	526
Weight (kg)	310	500	690	900
A	500	587	642	681
B	320	340	395	400
C	702	842	858	950
D	450	540	555	647
E	190	200	200	200
F	420	521	573	585
G	250	260	260	347
H	200	370	295	300
I	136	198	228	258
J	35	51	53	48
K	200	286	295	300
L	270	270	300	400
M	95	105	130	200
N	260	338	372	388

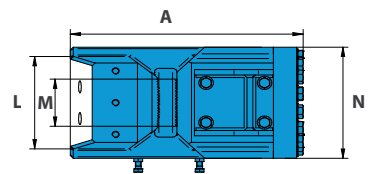
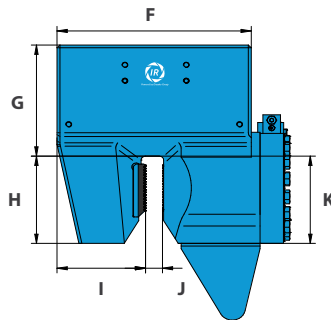
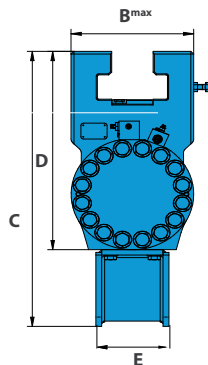
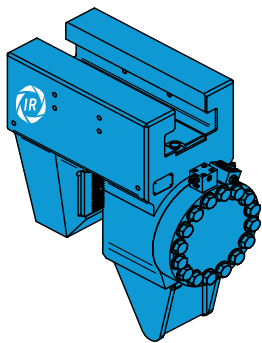

Stock locations: • Dronten (NL) • Sliedrecht (NL) • Hohenwart (DE) • Hamburg (DE) • Großwallstadt (DE)

Tube clamp

Tube clamp

InfraRentals supported by Dieseko Group

IR 150TC

IR 175TC

IR 200TC

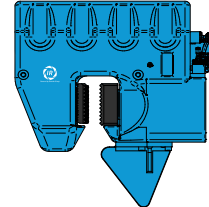
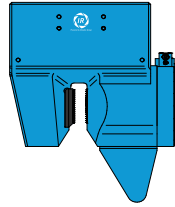
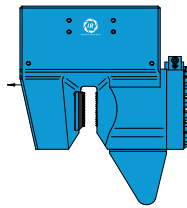

Clamping force (kN)	1500	1750	2000
Working pressure (bar)	300	300	320
Max. operating press. (bar)	180	180	180
Min. inside tube ø (mm)	638	638	725
Weight (kg)	1300	1300	1350
A	797	797	915
B	420	420	355
C	1040	1040	1092
D	750	750	747
E	250	250	40
F	665	665	840
G	420	420	396
H	330	330	400
I	303	303	353
J	58	58	54
K	330	330	351
L	349	349	355
M	180	178	244
N	420	420	430

Tube clamp options

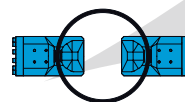
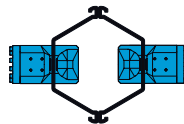
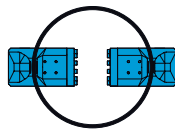
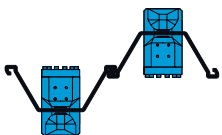

Stock locations: • Dronten (NL) • Sliedrecht (NL) • Hohenwart (DE) • Hamburg (DE) • Großwallstadt (DE)